

Model 08-FL / Model 10-FL



























*Avyna*







Round trampolines

Assembly manual

# Model 08-FL/ Model 10-FL



	Model 08-FL ø245cm			Model 10-FL ø305cm		
	Quantity	Part number		Quantity	Part number	
Jumping mat	1	TEPL-08-222		1	TEPL-10-222	
Galvanized spring L=175mm ø3.2mm	60	TEPL-200-211/C		72	TEPL-200-211/C	
Safety pad	1	TEPL-08-333-FL-green or AVGR-08-333-FL-grey or ABVL-08-333-FL black		1	TEPL-10-333-FL-green or AVGR-10-333-FL-grey or ABVL-10-333-FL-black	
Fastener for safety pad	12	TEPL-ELAS-D		18	TEPL-ELAS-D	
Fastener for safety pad	12	TEPL-ELAS-B		18	TEPL-ELAS-B	
H-tube	3	TEPL-08-FL-114		3	TEPL-10-FL-114	
H-tube	3	TEPL-08-FL-115		3	TEPL-10-FL-115	
C-tube	3	TEPL-08-113		3	TEPL-10-113	
K-tube	3	TEPL-08-114		3	TEPL-10-114	
Tool for spring	1	TOOL-SPRING		1	TOOL-SPRING	
Screw	6	M8-16		6	M8-16	
Plastic plate	3	2108-121		3	2110-121	

	Model 08-FL ø245cm			Model 10-FL ø305cm		
	Quantity	Part number		Quantity	Part number	
Parker screw	24	M4-16		24	M4-16	
Measuring rod L=220mm	1	MEASURING-ROD / A		1	MEASURING-ROD / A	
Measuring rod L=600mm	1	MEASURING-ROD / B		1	MEASURING-ROD / B	
Users Manual	1	208010101		1	208010101	
Warning Card	1	208040101		1	208040101	
Tie rip for warning card	1	209010102		1	209010102	
Safety manual	1	208010301		1	208010301	

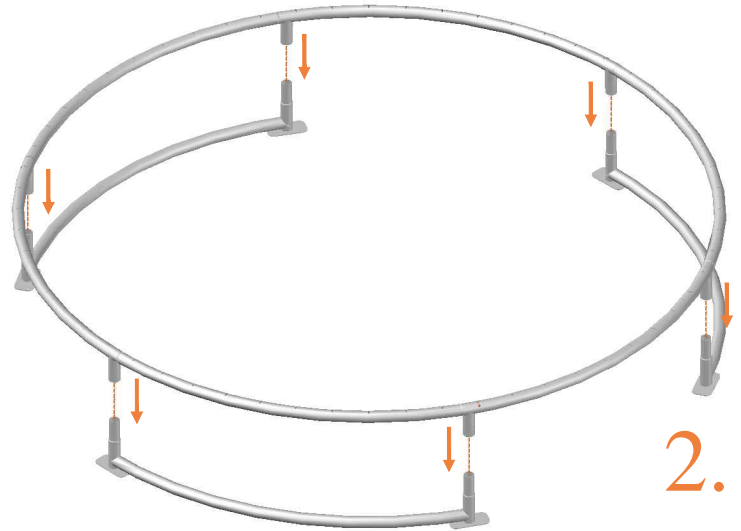
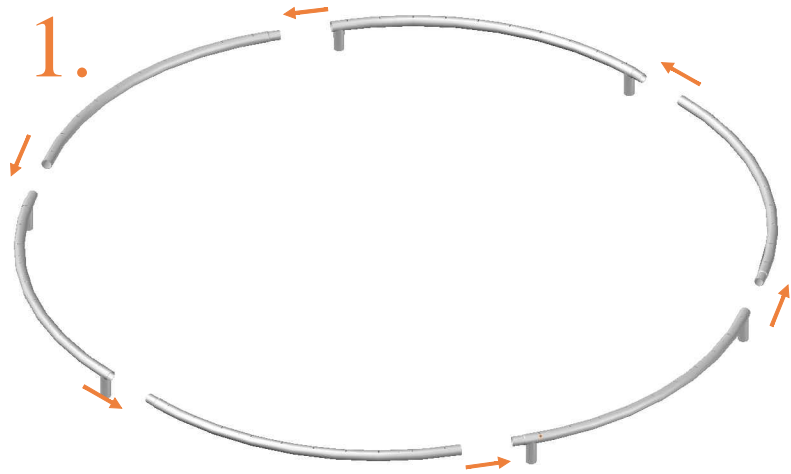

3.

TEPL-08-fl-114 / TEPL-10-fl-114

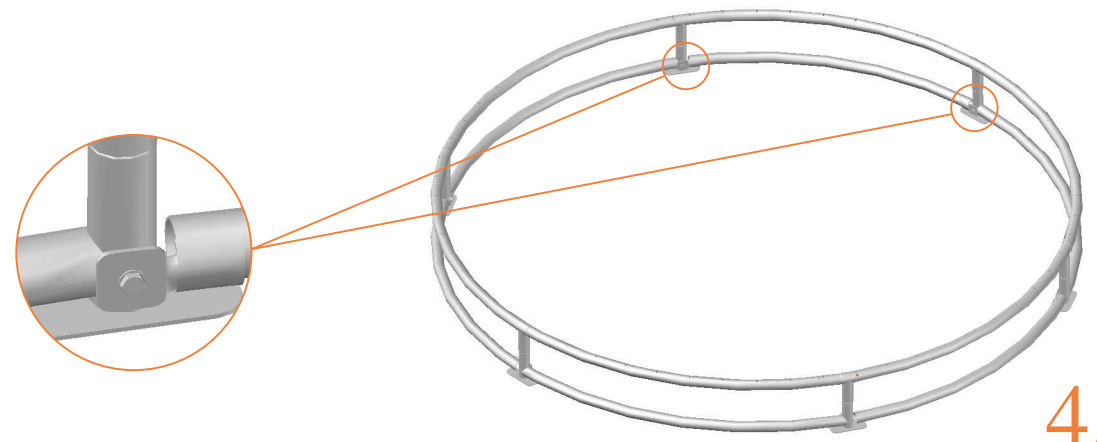
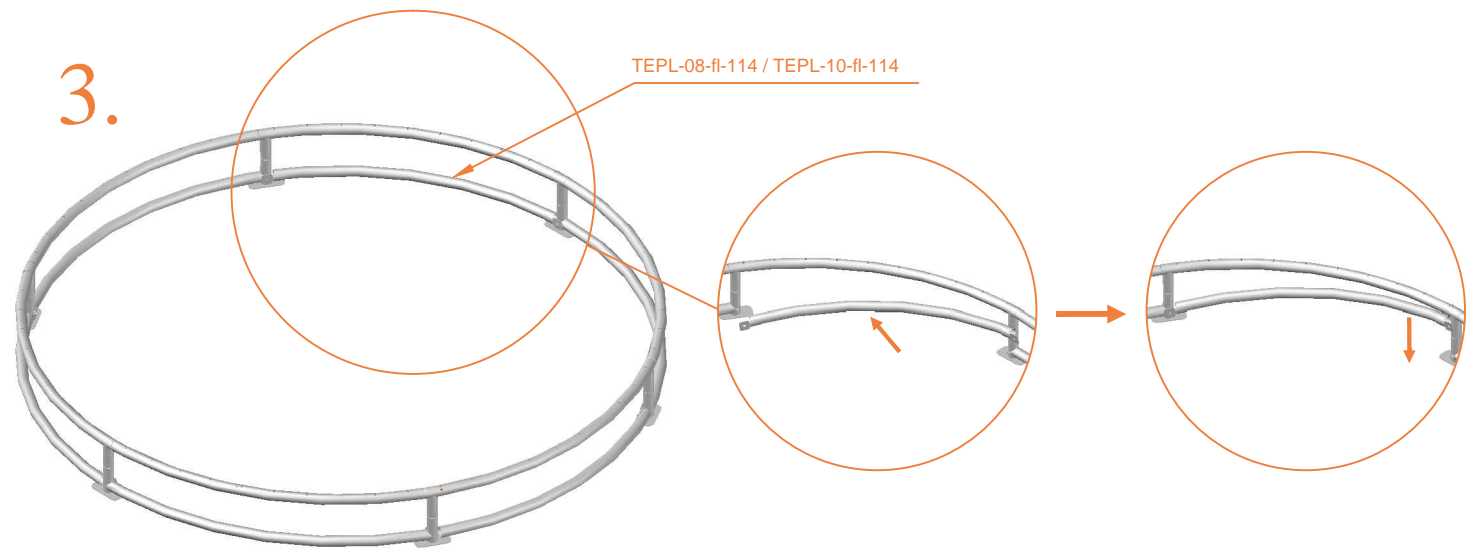

4.

5.

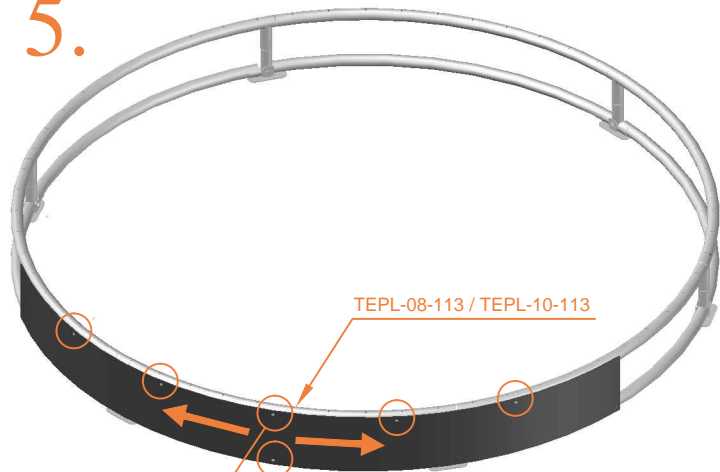

6.

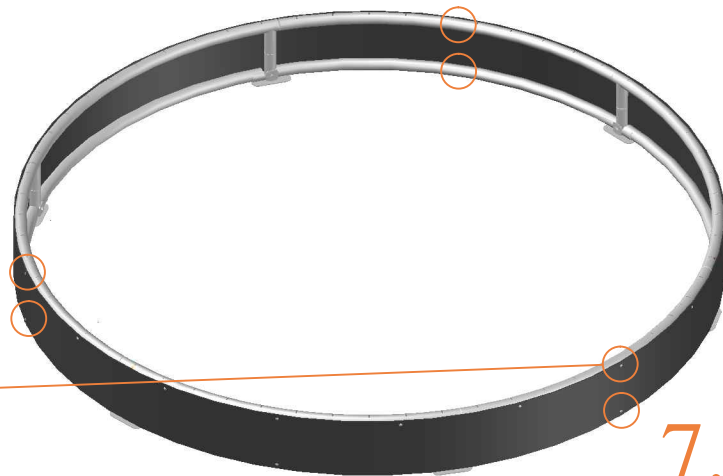
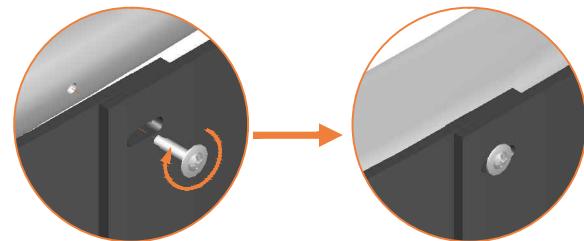
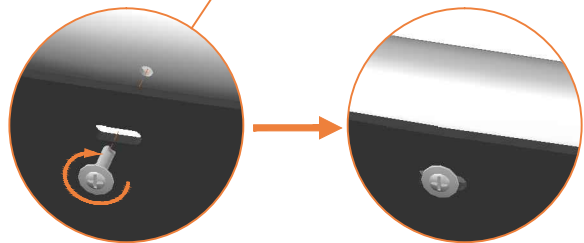
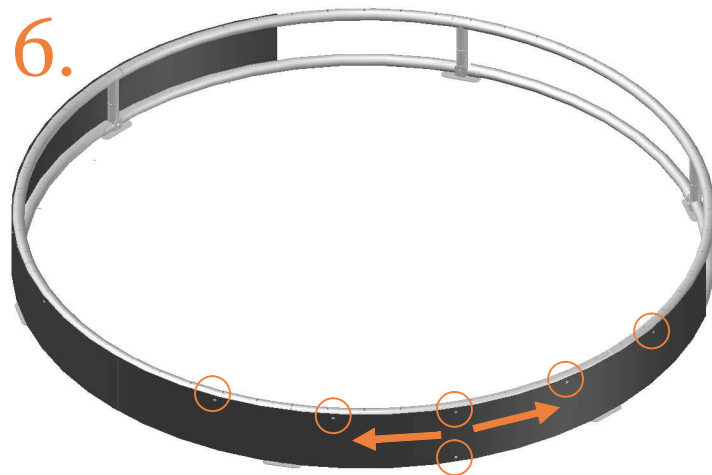

7.

8.

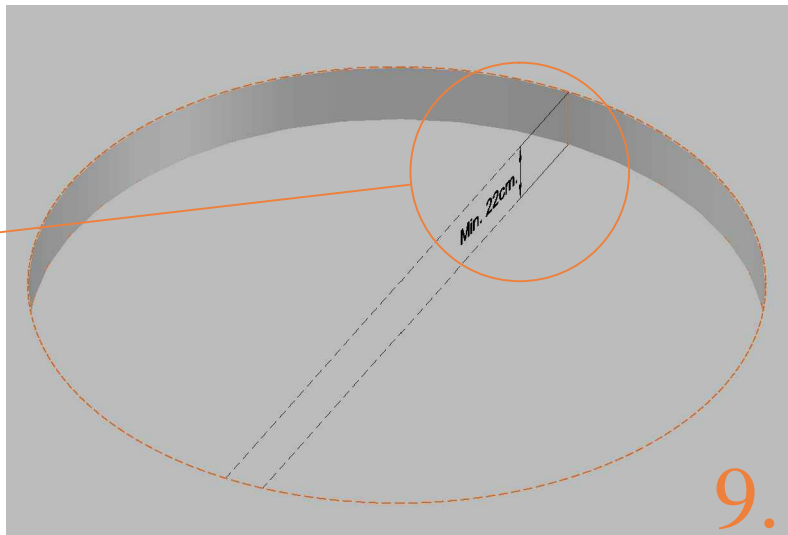
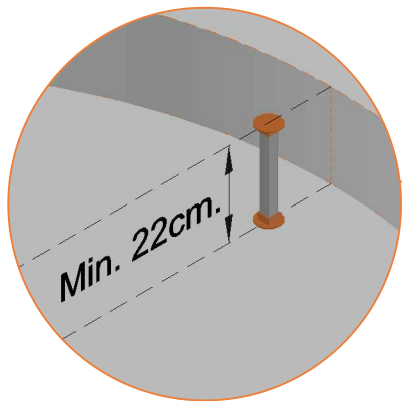
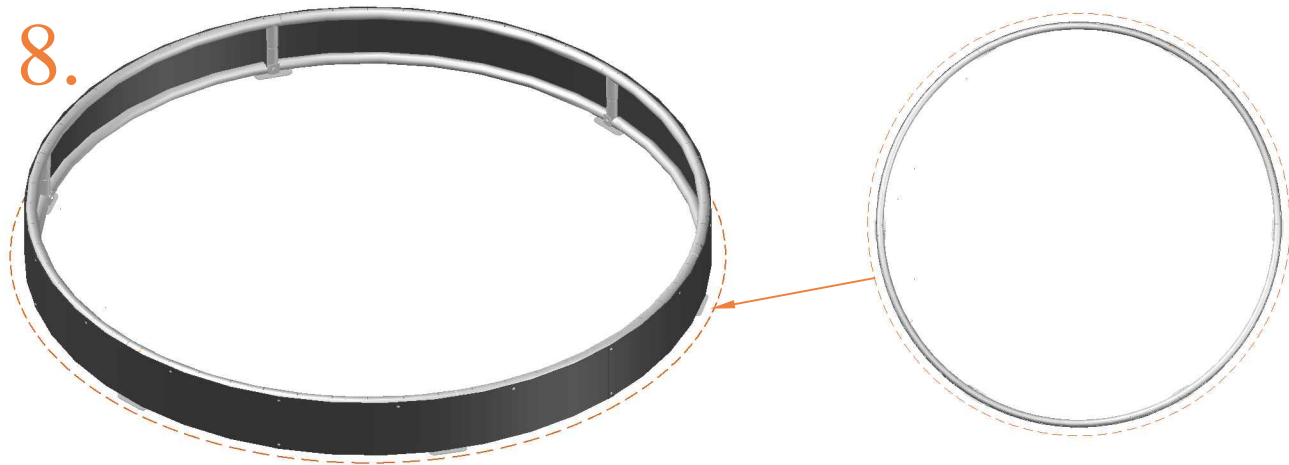

9.



10.

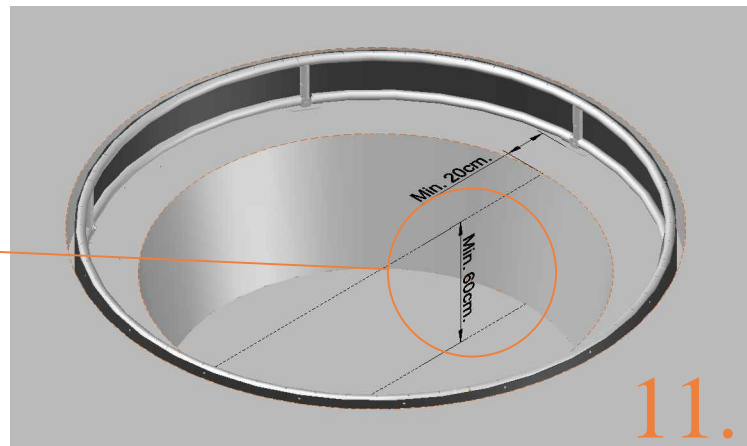
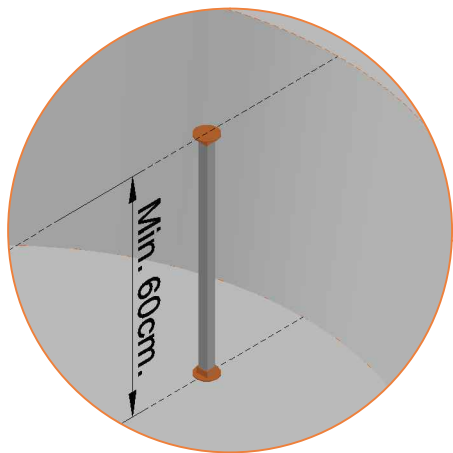
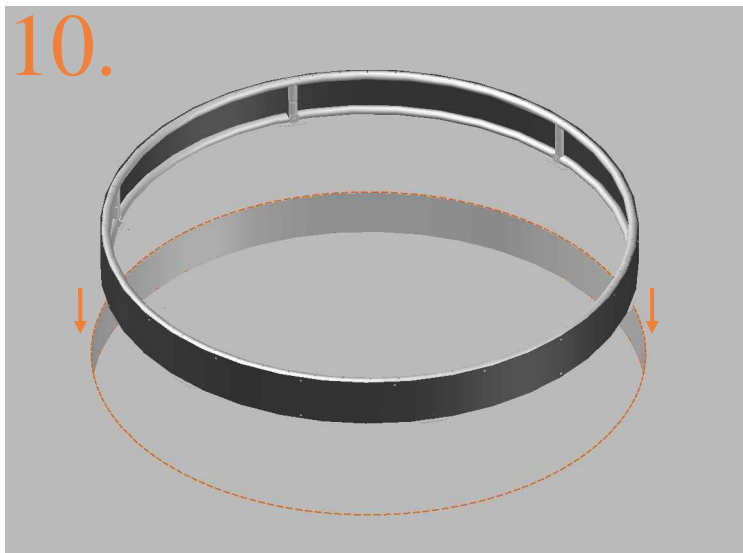

11.

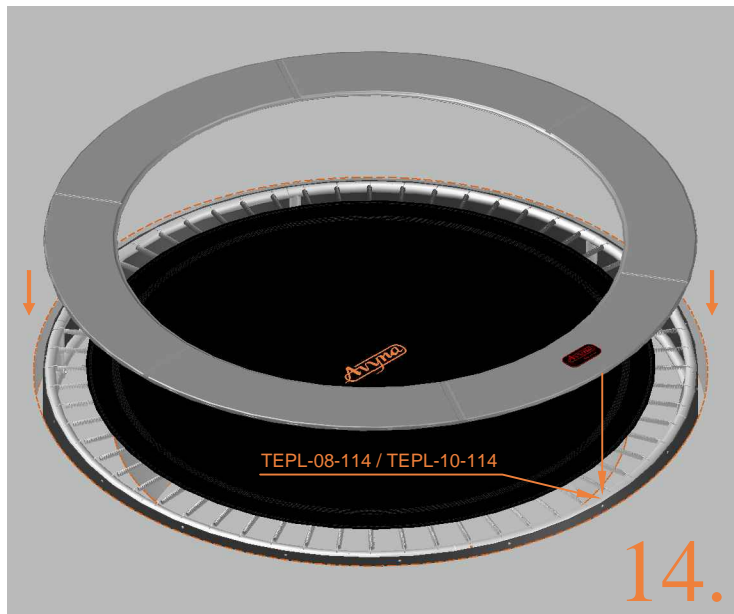
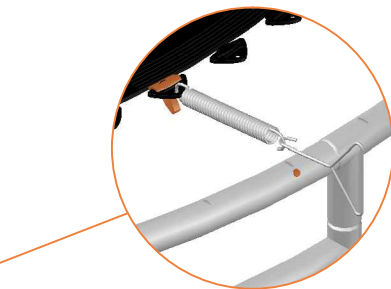

15.

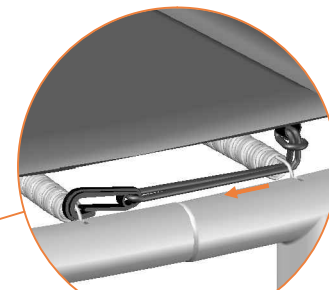
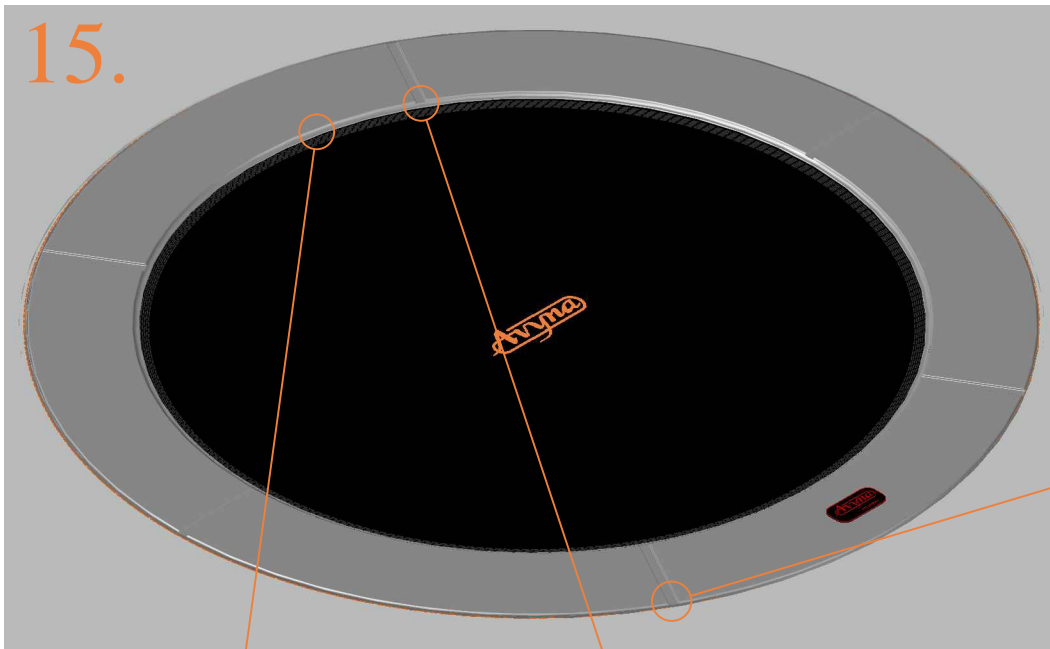

TEPL-ELAS-D

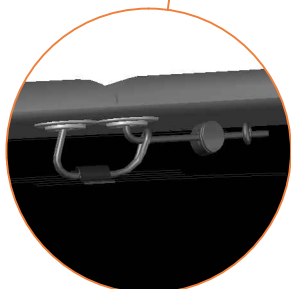

TEPL-ELAS-B

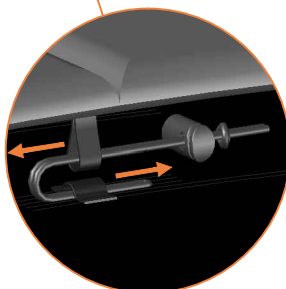



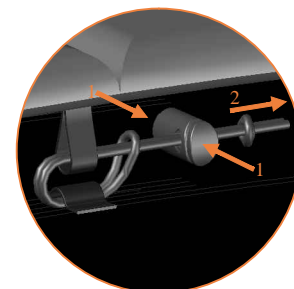























TEPL-ELAS-B



## Safety net for Model 08-FL / Model 10-FL



	Model 08-FL ø245cm			Model 10-FL ø305cm		
	Quantity	Part number		Quantity	Part number	
Pole with sleeve for safety net	6	AVBL-08-802-A + AVBL-08-802-C		6	AVBL-08-802-A + AVBL-08-802-C	
Pole for safety net	6	AVBL-08-802-B		6	AVBL-10-802-B	
Clamp	6	CLAMP-TOOL-SN 08-fl		6	CLAMP-TOOL-SN 10-fl	
Fiberglass Rod	1set	FIBERGLASS-ROD-08-fl		1set	FIBERGLASS-ROD-10-fl	
Screw M6x30	6	M6x30		6	M6x30	
Fastener for safety net	6	TEPL-ELAS-C		12	TEPL-ELAS-C	
Safety net	1	ANBL08-FL		1	ANBL-10-FL	
Straps for safety net	6	TEPL-BAND		6	TEPL-BAND	
Closure for safety net	2	TEPL-KNOOPJE		2	TEPL-KNOOPJE	
Screw M8	24	M8-20		24	M8-20	
Allen key	2	ALLEN-KEY		2	ALLEN-KEY	
Wrench	2	WRENCH		2	WRENCH	
Cap	6	TOP-CAP-BD		6	TOP-CAP-BD	

5.

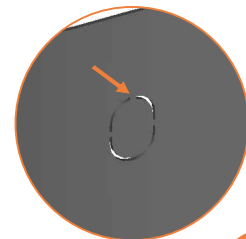
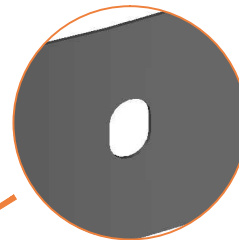
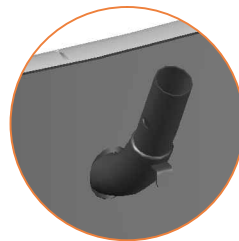
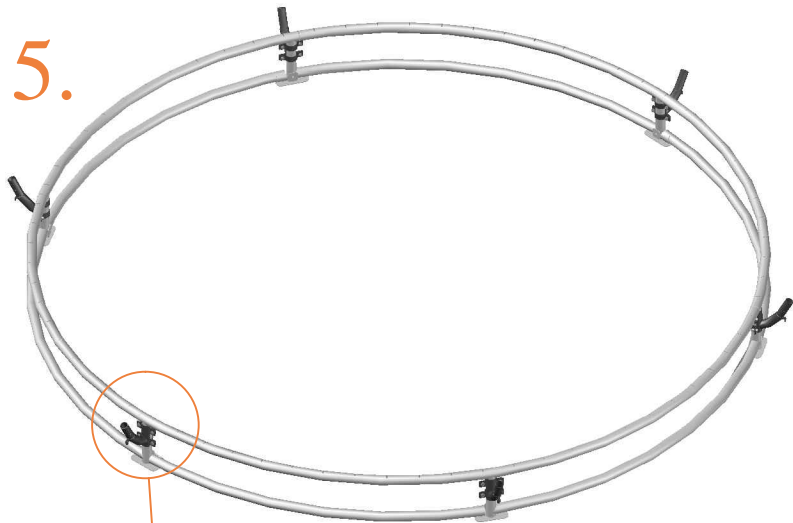

TEPL-08-113 / TEPL-10-113

6.

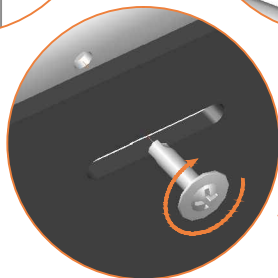
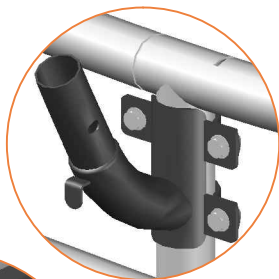
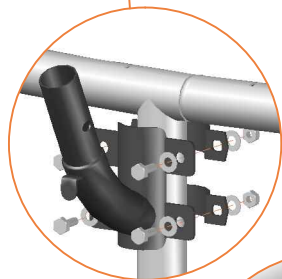
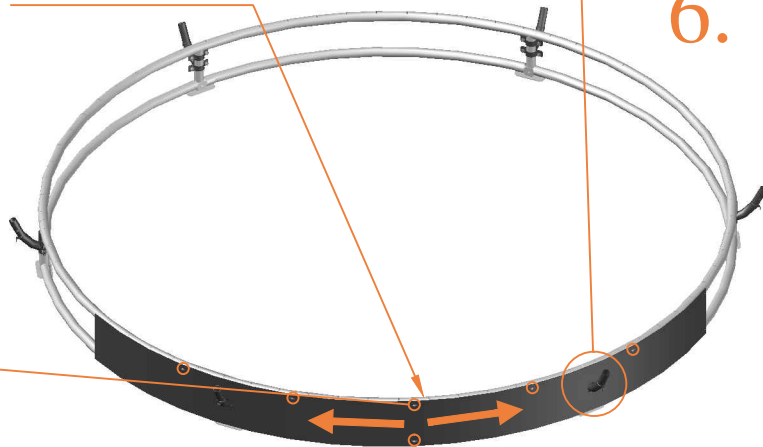

7.

8.

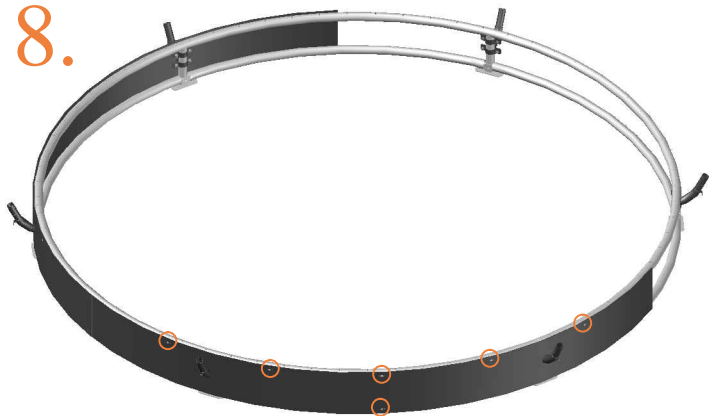

9.

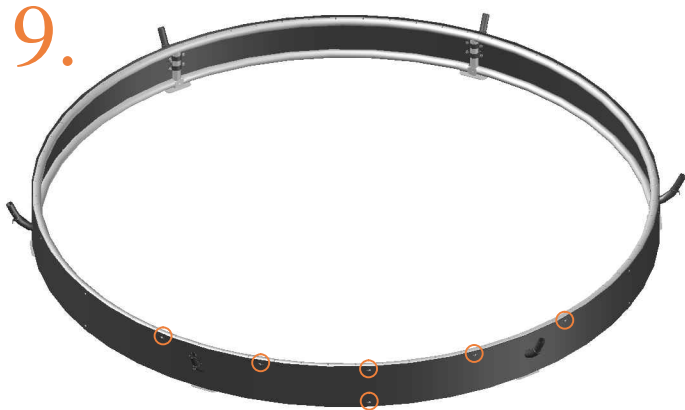

10.

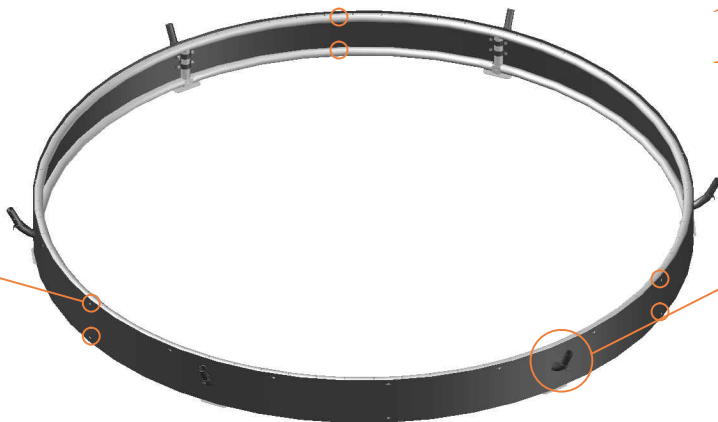

11.

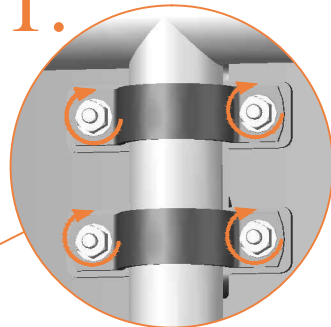

12.

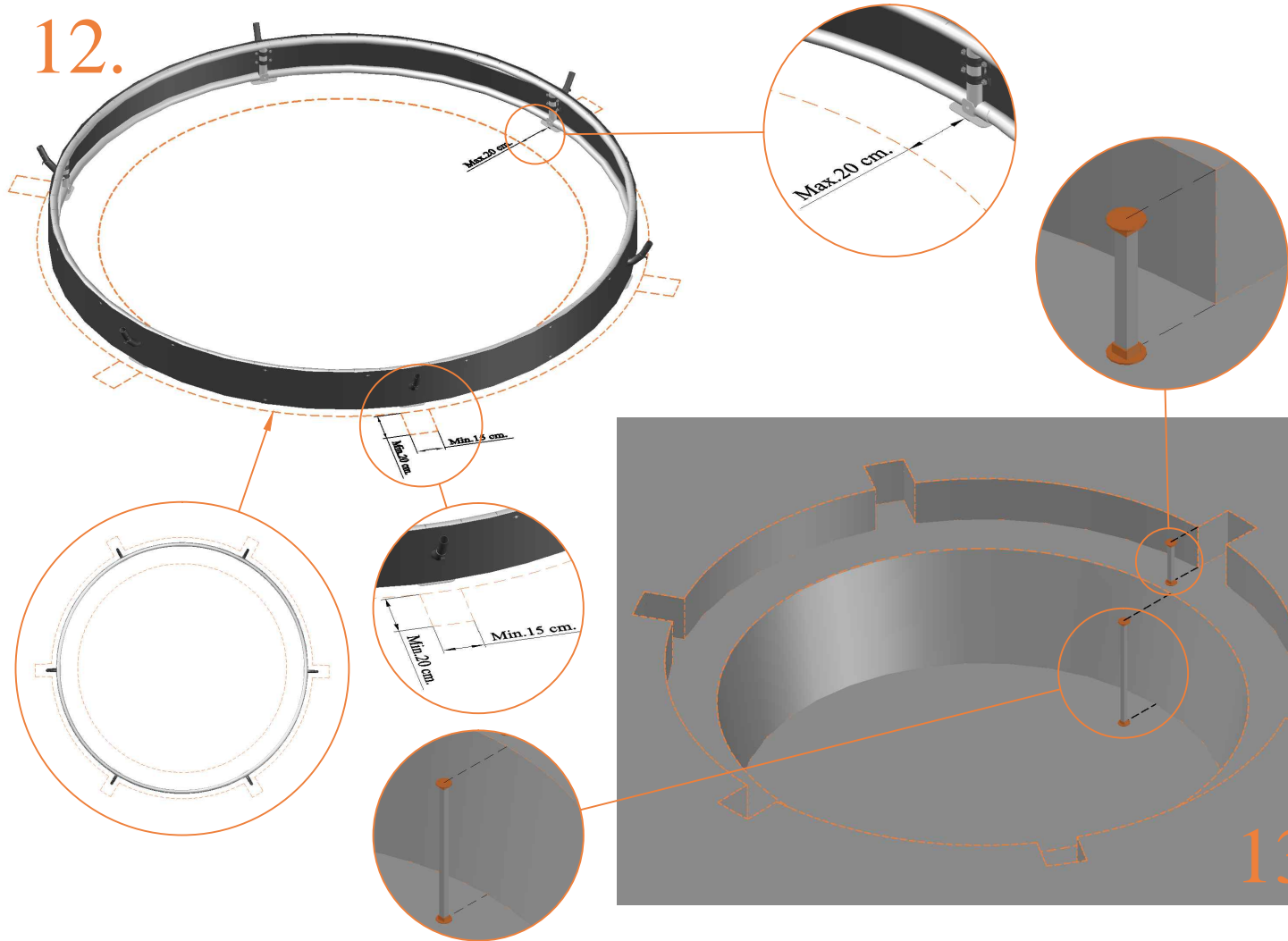



14.



15.

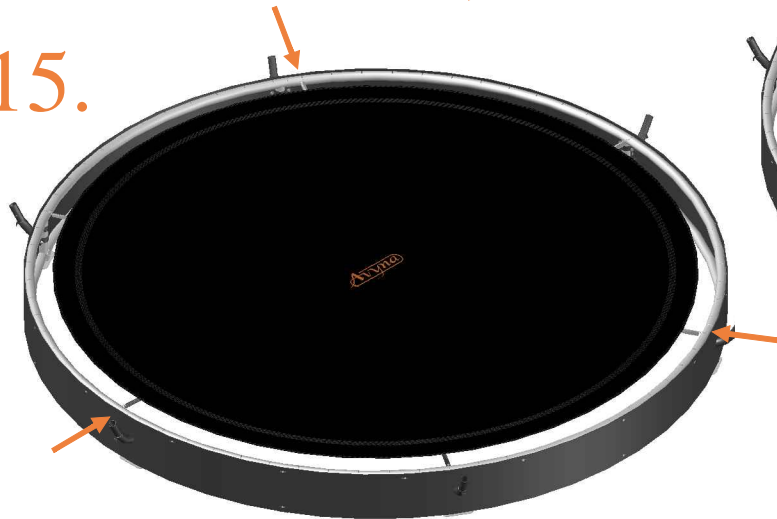

16.

17.

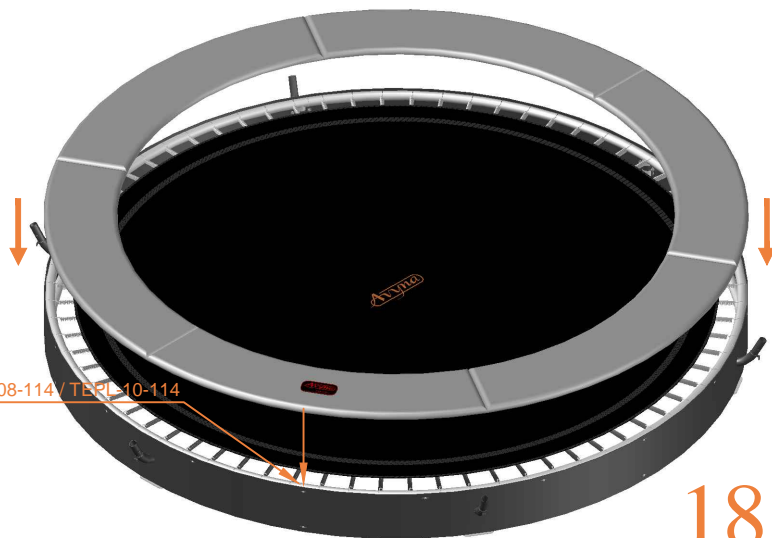

TEPL-08-114 / TEPL-10-114

18.



TEPL-ELAS-B



TEPL-ELAS-B

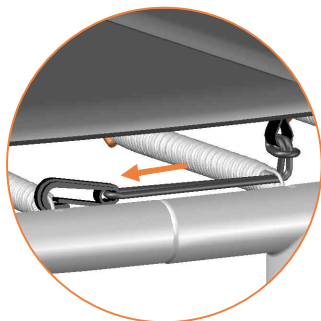
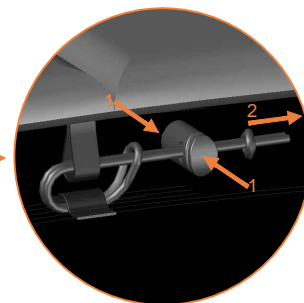

TEPL-ELAS-D

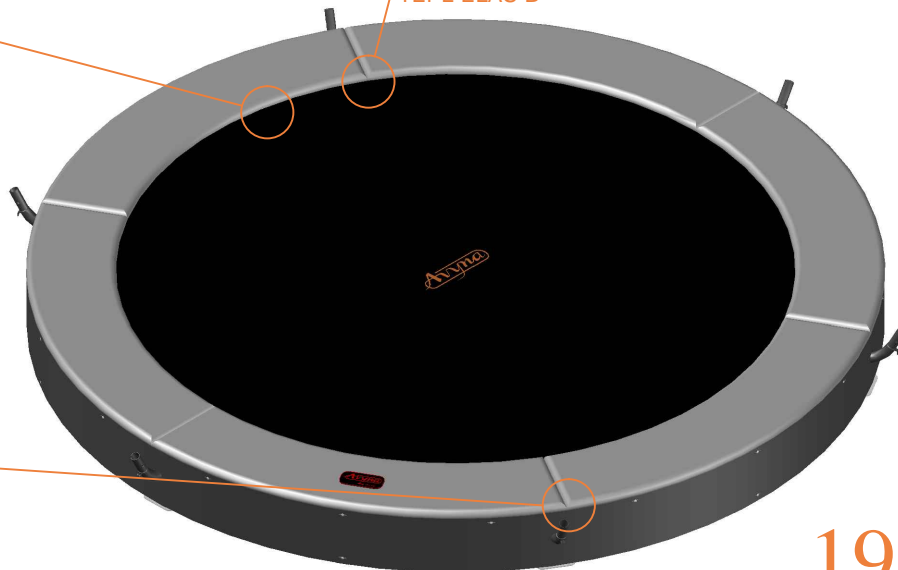

19.

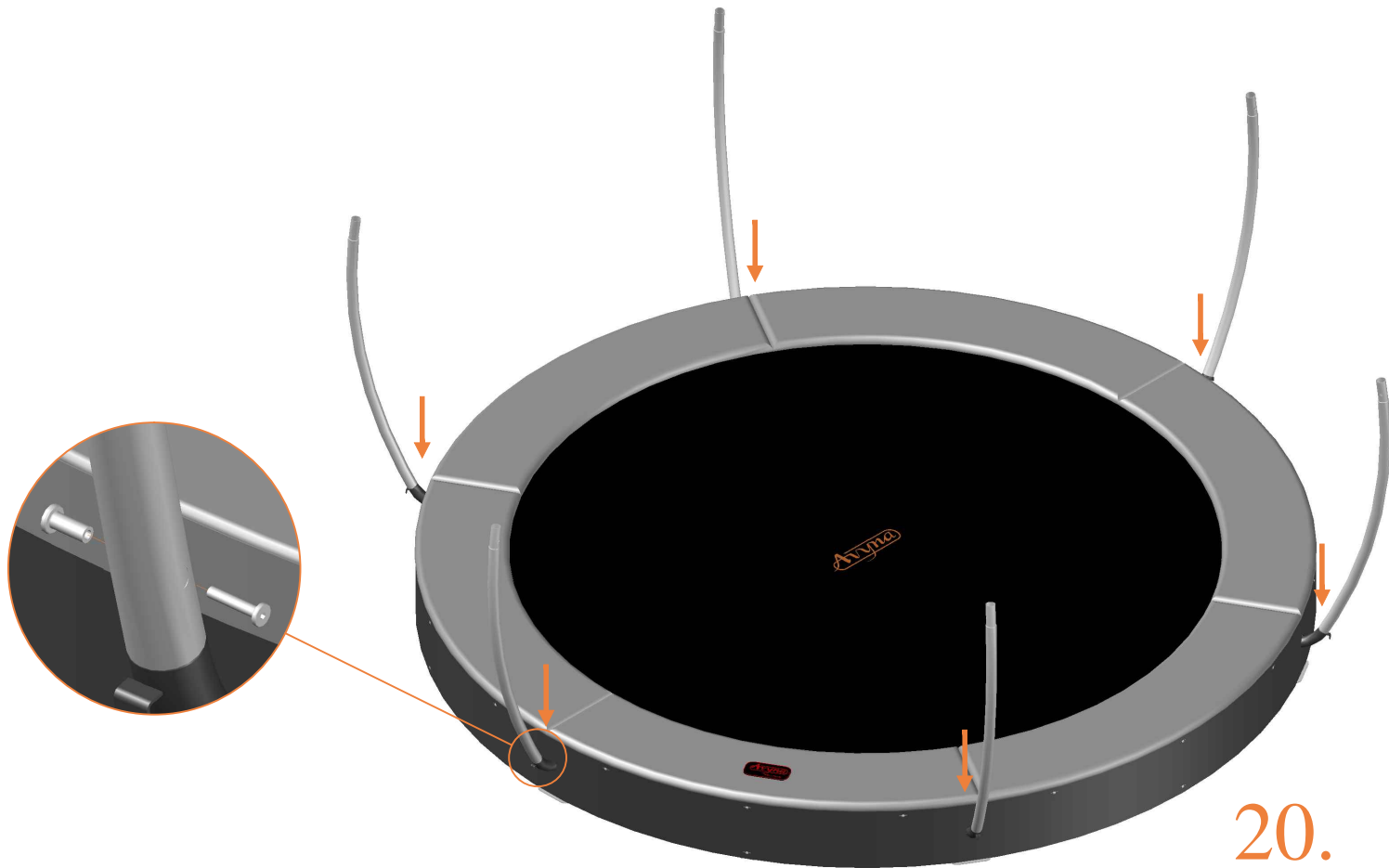

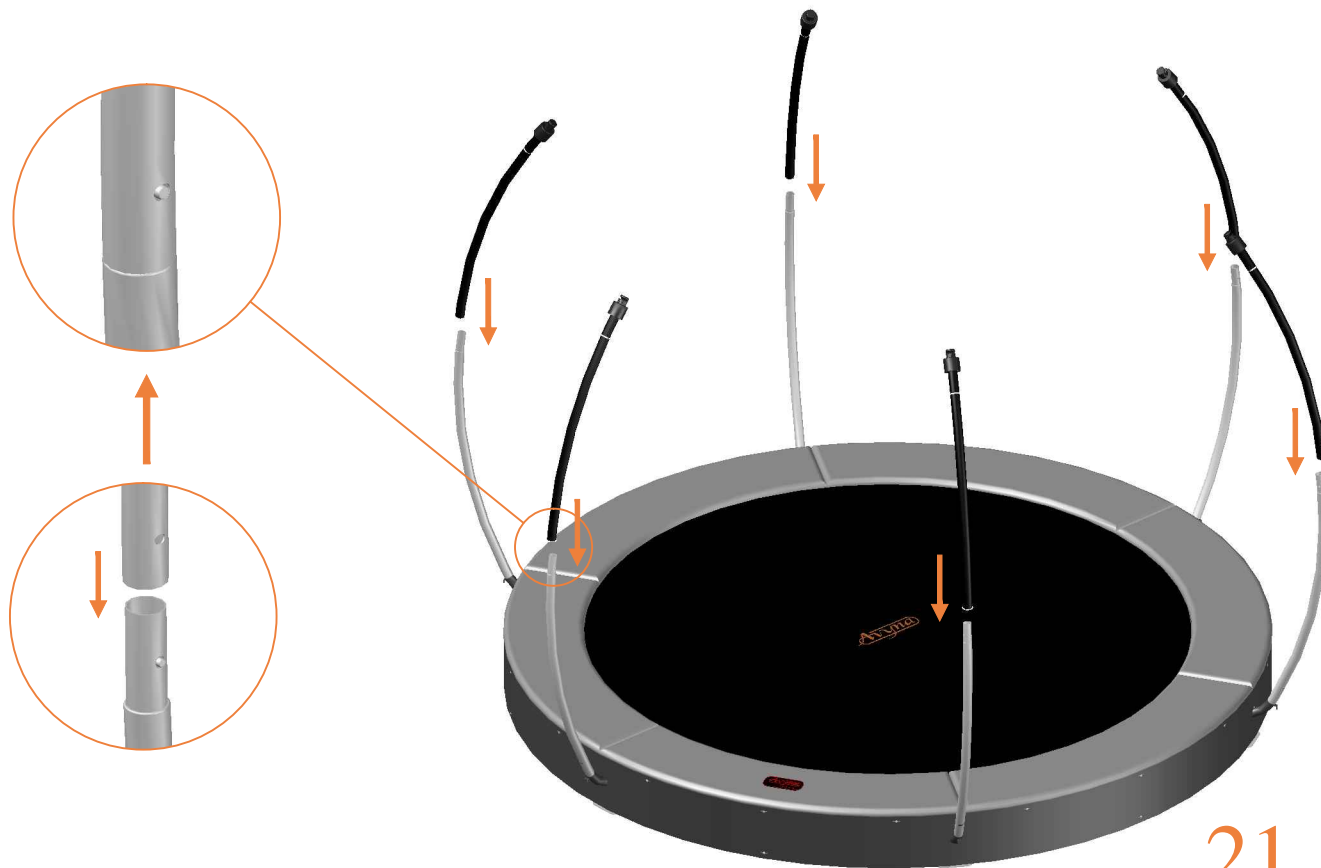

21.

22.

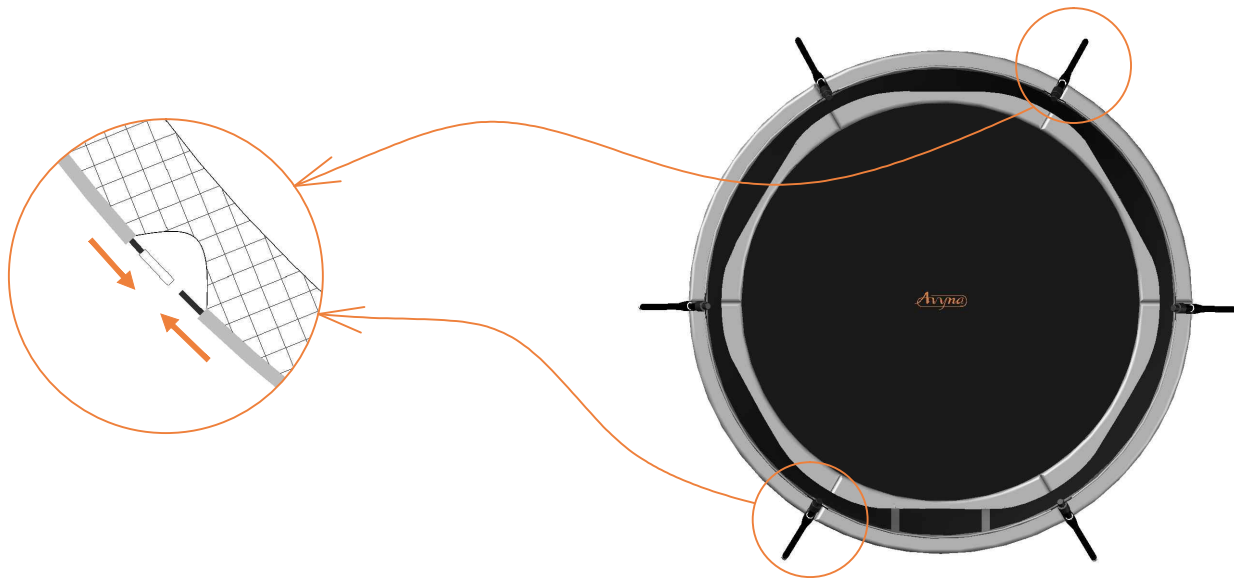
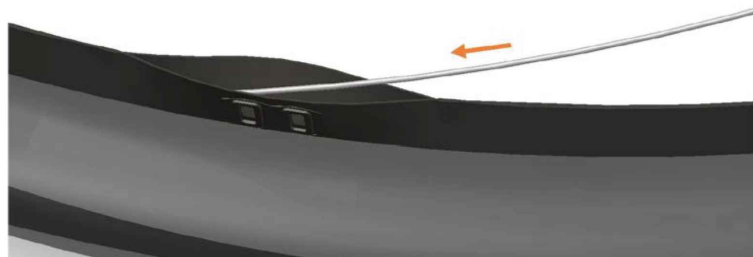



23.

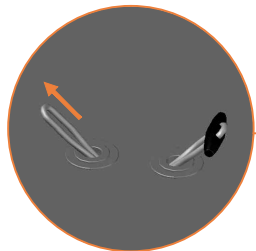
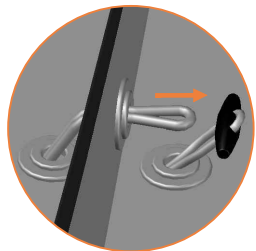
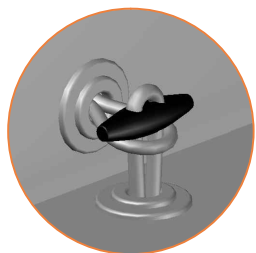

TEPL-ELAS-C

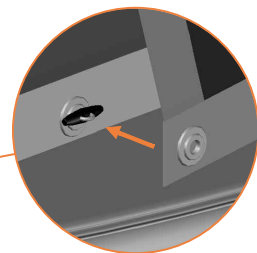

24.



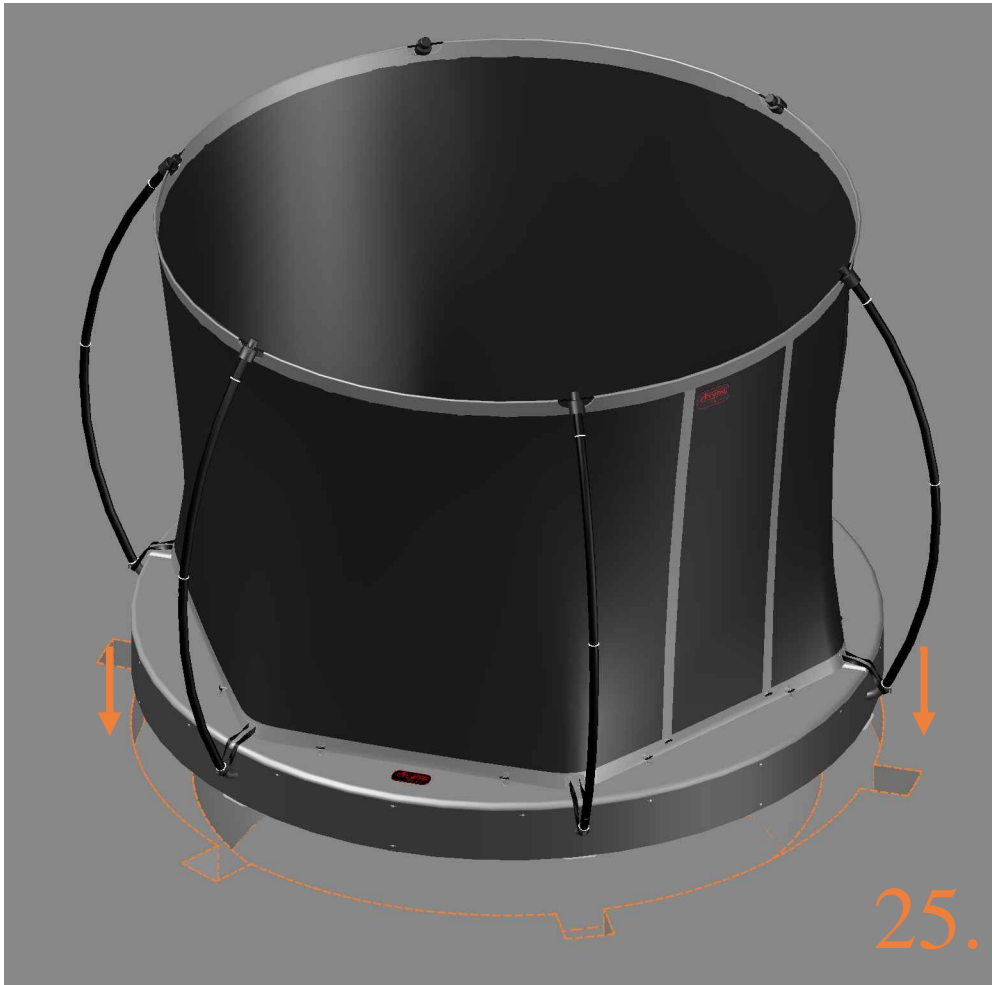



26.



Sales office: Beneluxbaan 7  
5121 DC Rijen  
The Netherlands  
[sales@avyna.eu](mailto:sales@avyna.eu)  
[www.avyna.eu](http://www.avyna.eu)